

描述 / Descriptions

BRCL3130CZF 产品是单节锂离子/锂聚合物可充电电池组保护的高集成度解决方案。BRCL3130CZF 包括了先进的功率 MOSFET，高精度的电压检测电路和延时电路。

BRCL3130CZF 具有非常小的 DFN2×2-6L 的封装，这使得该器件非常适合应用于空间限制得非常小的可充电电池组应用。BRCL3130CZF 具有过充，过放，过流，短路等所有的电池所需要保护功能，并且工作时功耗非常低。该芯片不仅仅为手机而设计，也适用于一切需要锂离子或锂聚合物可充电电池长时间供电的各种信息产品的应用场合。

The BRCL3130CZF series product is a high integration solution for lithium-ion/polymer battery protection. BRCL3130CZF contains advanced power MOSFET, high-accuracy voltage detection circuits and delay circuits.

BRCL3130CZF is put into an ultra-small DFN2×2-6L package and only one external component makes it an ideal solution in limited space of battery pack. BRCL3130CZF has all the protection functions required in the battery application including overcharging, overdischarging, overcurrent and load short circuiting protection etc. The accurate overcharging detection voltage ensures safe and full utilization charging. The low standby current drains little current from the cell while in storage. The device is not only targeted for digital cellular phones, but also for any other Li-Ion and Li-Poly battery-powered information appliances requiring long-term battery life.

特征 / Features

- ◆ 内部集成等效 45mΩ 的先进的功率 MOSFET；
- ◆ 超小封装 DFN2×2-6L；
- ◆ 过温保护；过充电电流保护；过放电电流；负载短路电流；
- ◆ 充电器检测；0V 电池充电功能，延迟时间内部设定，高精度电压检测；
- ◆ 低静态电流：正常工作电流：3.0uA；待机电流：<0.1uA；
- ◆ 非过放自恢复，需要激活；
- ◆ 无卤产品。
- ◆ Integrate advanced power MOSFET with Equivalent of 45mΩ $R_{DS(ON)}$;
- ◆ Ultra-small DFN2×2-6L package;
- ◆ Over-temperature Protection; Overcharge Current Protection; Overdischarge Current; Load Short Circuiting.
- ◆ Charger detection function; 0V battery charging function; delay times are generated inside; High-accuracy voltage detection.
- ◆ Low Current Consumption; Operation Mode: 3.0μA typ; Power-down Mode: <0.1uA typ ;
- ◆ The Overdischarge is not self recovery and needs to be activated;
- ◆ Halogen-free Product.

用途 / Applications

单芯锂离子电池组；锂聚合物电池组。

One-Cell lithium-ion battery pack; Lithium-Polymer battery pack.

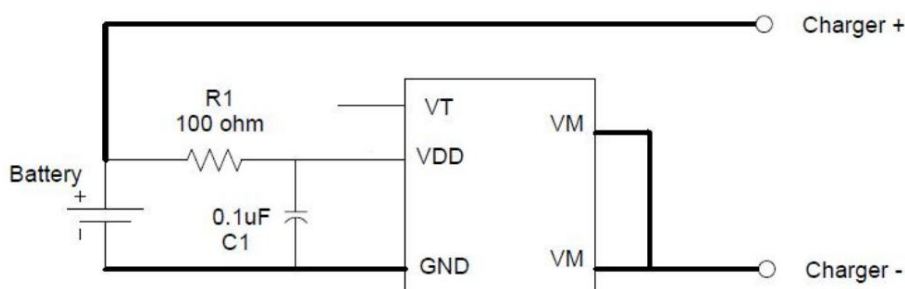
典型应用电路图 / Typical Application

引脚排列 / Pinning

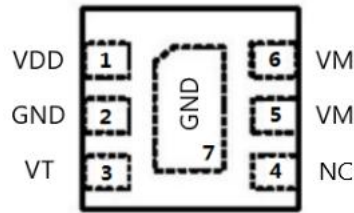
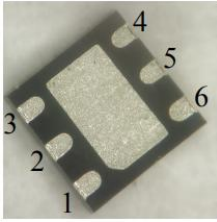

引脚编号 Pin Number	引脚名称 Pin Name	引脚说明 Pin Description
1	VDD	Power Supply
2、7	GND	Ground, connect the negative terminal of the battery to this pin.
3	VT	Internal test pin.
4	NC	No electrical connection.
5、6	VM	The negative terminal of the charger. The internal FET switch connects this terminal to GND.

印章代码 / Marking

见印章说明。 See Marking Instructions.

极限参数 / Absolute Maximum Ratings(Ta=25°C)

参数/Parameter	符号/Symbol	数值/Value	单位/Unit
V _{DD} input pin voltage	V _{IN}	-0.3 to +6	V
V _M input pin voltage	V _{VM}	-9 to +10	V
Maximum Junction Temperature	T _J	125	°C
Lead Temperature	T _L	300	°C
Operating Junction Temperature	T _{opr}	-40 to +85	°C
Storage Temperature	T _{stg}	-55 to +150	°C
Package Thermal Resistance	R _{θJA}	250	°C/W
	R _{θJc}	130	°C/W
ESD (HBM)	ESD	2000	V

电性能参数 / Electrical Characteristics(除非特别指定, Ta=25°C)

参数/Parameter	符号 /Symbol	测试条件/Test Condition	最小值 /Min	典型值 /Typ	最大值 /Max	单位 /Unit
Overcharge Detection Voltage	V _{CU}		4.25	4.30	4.35	V
Overcharge Release Voltage	V _{CL}		4.05	4.10	4.15	V
Overdischarge Detection Voltage	V _{DL}		2.72	2.80	2.88	V
Overdischarge Release Voltage	V _{DR}		2.92	3.00	3.08	V
Charger Detection Voltage	V _{CHA}		-0.3	-0.4	-0.5	V
Overcharge Current Detection	I _{IOCC}	V _{dd} =3.6V	0.3	0.7	1	A
Overdischarge Current1 Detection	I _{IOV1}	V _{dd} =3.6V	0.3	0.7	1	A
Overdischarge Current2 Detection	I _{IOV2}	V _{dd} =3.6V	3	4.5	6	A
Load Short-Circuiting Detection	I _{SHORT}	V _{dd} =3.6V		15		A
Current Consumption in Normal Operation	I _{OPE}	V _{dd} =3.5V, V _M =0V		3.0	4.5	μA
Current Consumption in power Down	I _{PDN}	V _{dd} =2V, V _M floating			0.1	μA
Equivalent FET on Resistance	R _{DS}	V _{dd} =3.6V, I _{VM} =0.3A		45		mΩ
Over Temperature Protection	T _{SHD+}			140		°C
Over Temperature Recovery Degree	T _{SHD-}			115		°C
Overcharge Current Detection Delay Time	T _{OCC}	V _{dd} =3.6V	7	9	11	ms
Overcharge Voltage Detection Delay Time	T _{CU}	V _{dd} =3.6V~4.4V	125	155	184	ms
Overdischarge Voltage Detection Delay Time	T _{DL}	V _{dd} =3.6V~2.0V	30	40	50	ms
Overdischarge Current1 Detection Delay Time	T _{IOV1}	V _{dd} =3.6V	7	9	11	ms
Overdischarge Current2 Detection Delay Time	T _{IOV2}	V _{dd} =3.6V	0.8	1.2	1.6	ms
Load Short-Circuiting Detection Delay Time	T _{SHORT}	V _{dd} =3.6V		100	200	us

功能框图 / Functional Block Diagram

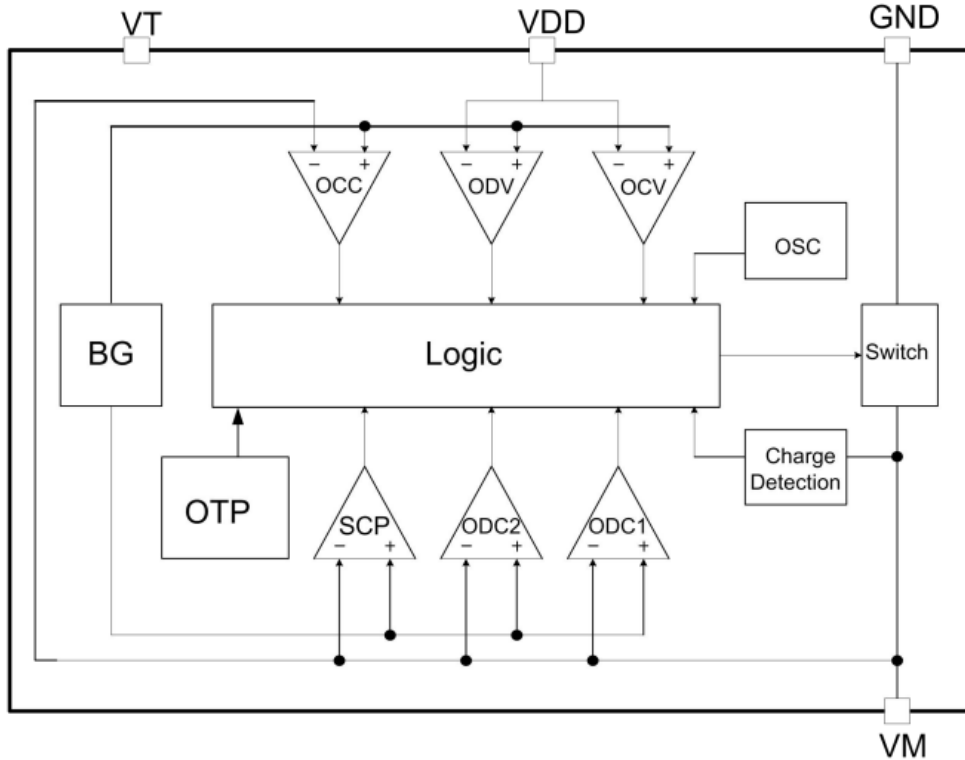

功能描述 / Functional Description

BRCL3130CZF监控电池的电压和电流，并通过断开充电器或负载，保护单节可充电锂电池不会因为过充电电压，过放电压，过充电流，过放电流以及短路等情况而损坏。系统外围电路简单。MOSFET已内置，等效电阻典型值为45mΩ。

The BRCL3130CZF monitors the voltage and current of a battery and protects it from being damaged due to overcharge voltage, overdischarge voltage, overdischarge current, and short circuit conditions by disconnecting the battery from the load or charger. The peripheral circuit is very simple. The MOSFET is integrated and its $R_{DS(ON)}$ is as low as 45mΩ typical.

正常工作模式 / Normal Operating mode

如果没有检测到任何异常情况，输出管一直打开，充电和放电过程都将自由转换。这种情况称为正常工作模式。

If no exception condition is detected, charging and discharging can be carried out freely. This condition is called the normal operating mode.

过充电情况 / Overcharge Condition

在正常条件下的充电过程中，当电池电压高于过充检测电压（VCU），并持续时间达到过充电电压检测延迟时间（TCU）或更长，BRCL3130CZF将关断FET以停止充电。这种情况称为过充电电压情况。

以下两种情况下，过充电电压情况将被释放：

（1）当电池电压低于过充解除电压（VCL），BRCL3130CZF打开输出管，回到正常工作模式。

（2）当连接一个负载进行放电，BRCL3130CZF打开输出管，回到正常工作模式。解除机制如下：接上负载后放电电流立刻流过输出管的内部寄生二极管，VM电压升到0.7V（即二极管的正向压降），BRCL3130CZF检测到这个电压后，将过充电电压阈值切换到VCU，接下来，当电池电压低于过充检测电压（VCU），BRCL3130CZF立刻恢复到正常工作模式，但是如果电池电压高于过充检测电压（VCU），即使负载是接着的，芯片也不会恢复到正常工作模式，必须要等到电池电压低于过充检测电压（VCU）。另外，在接上负载放电时，如果VM电压等于或低于过电流1检测电压，芯片不会恢复到正常工作模式。

注：当电池被充电到超过过充检测电压（VCU）并且电池电压没有降到过充检测电压（VCU）以下，即使加上一个可以导致过流的重载，过流1和过流2都不会工作，除非电池电压跌倒过充检测（VCU）以下。但是实际上电池是有内阻的，当电池接上一个重载，电池的电压会立即跌落，这时过流1和过流2就会动作。

When the battery voltage becomes higher than the overcharge detection voltage (VCU) during charging under normal condition and the state continues for the overcharge detection delay time (TCU) or longer, the BRCL3130CZF turns the charging control FET off to stop charging. This condition is called the overcharge condition.

The overcharge condition is released in the following two cases:

（1）When the battery voltage drops below the overcharge release voltage (VCL), the BRCL3130CZF turns the charging control FET on and returns to the normal condition.

（2）When a load is connected and discharging starts, the BRCL3130CZF turns the charging control FET on and returns to the normal condition. The release mechanism is as follows: the discharging current flows through an internal parasitic diode of the charging FET immediately after a load is connected and discharging starts, and the VM pin voltage increases about 0.7 V (forward voltage of the diode) from the GND pin voltage momentarily. The BRCL3130CZF detects this voltage and releases the overcharge condition. Consequently, in the case that the battery voltage is equal to or lower than the overcharge detection voltage (VCU), the BRCL3130CZF returns to the normal condition immediately, but in the case the battery voltage is higher than the overcharge detection voltage (VCU), the chip does not return to the normal condition until the battery voltage drops below the overcharge detection voltage (VCU) even if the load is connected. In addition, if the VM pin voltage is equal to or lower than the overcurrent 1 detection voltage when a load is connected and discharging starts, the chip does not return to the normal condition.

Note: If the battery is charged to a voltage higher than the overcharge detection voltage (VCU) and the battery voltage does not drop below the overcharge detection voltage (VCU) even when a heavy load, which causes an overcurrent, is connected, the overcurrent 1 and overcurrent 2 do not work until the battery voltage drops below the overcharge detection voltage (VCU). Since an actual battery has, however, an internal impedance of several dozens of mΩ, and the battery voltage drops immediately after a heavy load which causes an overcurrent is connected, the overcurrent 1 and overcurrent 2 work. Detection of load shortcircuiting works regardless of the battery voltage.

过放电压情况 / Overdischarge Condition

在正常放电过程中，当电池电压降到过放检测电压（V_{DL}）以下，并且持续时间达到过放电电压检测延时时间（T_{DL}）或更长，BRCL3130CZF将切断电池和负载的连接，停止放电。这种情况被称为过放电压情况。当控制放电的FET被关断，VM通过内部VM与VDD之间的RVMD电阻被拉到高电平，同时芯片的耗电电流会降到休眠电流（IPDN），这种情况被称为休眠情况。在过放和休眠情况中，VM和VDD之间由RVMD电阻连接。

备注：在电池处于过放电情况下接上充电器，如果VM端电压不低于充电检测电压（V_{CHA}），并且电池电压达到过放解除电压（V_{DR}）或更高，过放情况解除。

When the battery voltage drops below the overdischarge detection voltage (V_{DL}) during discharging under normal condition and it continues for the overdischarge detection delay time (t_{DL}) or longer, the BRCL3130CZF turns the discharging control FET off and stops discharging. This condition is called overdischarge condition. After the discharging control FET is turned off, the VM pin is pulled up by the RVMD resistor between VM and VDD in BRCL3130CZF, the current of the chip is reduced to the power-down current (IPDN). This condition is called power-down condition. The VM and VDD pins are shorted by the RVMD resistor.

Note: If the VM pin voltage is no less than the charger detection voltage (V_{CHA}), when the battery under overdischarge condition is connected to a charger, the overdischarge condition is released (the discharging control FET is turned on) as usual, provided that the battery voltage reaches the overdischarge release voltage (V_{DR}) or higher.

过放电流情况 / Overcurrent Condition

正常工作模式下，当放电电流等于或高于设定的值（VM电压等于或高于过电流检测电压），并且持续时间达到过放电流检测延迟时间，BRCL3130CZF关断放电FET，停止放电。这种情况称为过放电流情况（包括过放电流1，过放电流2和负载短路电流）。过放电流情况下，VM和GND被RVMS电阻给短接了。当一个负载连接上，VM电压等于VDD减去负载电阻上的电压。

由于VM和GND之间连接RVMS电阻，当负载断开，VM电压被拉到地电位。当检测到VM电位低于过流1检测电压，芯片回到正常状态。

When the discharging current becomes equal to or higher than a specified value (the VM pin voltage is equal to or higher than the overcurrent detection voltage) during discharging under normal condition and the state continues for the overcurrent detection delay time or longer, the BRCL3130CZF turns off the discharging control FET to stop discharging. This condition is called overcurrent condition. (The overcurrent includes overcurrent, or load shortcircuiting.) The VM and GND pins are shorted internally by the RVMS resistor under the overcurrent condition. When a load is connected, the VM pin voltage equals the VDD voltage due to the load.

Because of the connection between the VM and the GND by the RVMS resistor, when the load is removed, the VM pin goes back to the GND potential since the VM pin is shorted the GND pin with the RVMS resistor. Detecting that the VM pin potential is lower than the overcurrent detection voltage (V_{IOV1}), the IC returns to the normal condition.

异常充电电流检测 / Abnormal Charge Current Detection

正常充电时，如果VM电压降到过电流充电检测阈值以上（ I_{IOCC} ），并且持续时间超过过充电流检测延时时间，BRCL3130CZF关断充电FET停止充电。这种情况称为异常充电电流检测。

断开充电器，VM和GND之间电压高于充电器检测电压(VCHA)时，异常充电电流模式解除。由于0V电池充电功能优先级高于不正常电流充电检测，电池电压很低的电池正在进行0V充电时，异常充电电流检测将不工作。

If the VM pin voltage drops below the Overcharge Current Detection during charging under the normal condition and it continues for the overcharge detection delay time or longer, the BRCL3130CZF turns the charging control FET off and stops charging. This action is called abnormal charge current detection.

Abnormal charge current detection is released when the voltage difference between VM pin and GND pin becomes higher than the charger detection voltage (VCHA) by separating the charger. Since the 0 V battery charging function has higher priority than the abnormal charge current detection function, abnormal charge current may not be detected by the product with the 0 V battery charging function while the battery voltage is low.

负载短路情况 / Load Short-circuiting Condition

如果VM电压高于短路保护电压（VSHORT），并且持续时间超过短路检测延迟时间（ t_{SHORT} ），BRCL3130CZF将与负载断开停止放电。当VM电压低于短路保护电压（VSHORT）时，例如负载被移除，负载短路情况将解除。

If voltage of VM pin is higher short circuiting protection voltage (VSHORT) and it continues for the t_{SHORT} or longer, the BRCL3130CZF will stop discharging and battery is disconnected from load. This status is released when voltage of VM pin is higher than short protection voltage (VSHORT), such as when disconnecting the load.

0V 电池充电功能 / 0V Battery Charging Function

此功能用于对已经自放电到 0V的电池进行再充电。当充电器插上时，会通过内部二极管来给电池进行充电，当电池电压高于过放电检测电压（VDL）时，保护IC进入正常工作状态。

注：(1)某些完全自放电后的电池，不允许被再次充电，这是由锂电池的特性决定的。请询问电池供应商，确认所购买的电池是否具备“允许向 0V电池充电”的功能，还是“禁止向0V电池充电”的功能。

(2)“允许向0V电池充电功能”比“充电过流检测功能”优先级更高。因此,使用“允许向0V电池充电”功能的IC，在电池电压较低的时候会强制充电。电池电压低于过放电检测电压（VDL）以下时，不能进行充电过流状态的检测。

(3)当电池第一次接上保护电路时，这个电路可能不会进入正常模式，此时无法放电。如果产生这种现象，使VM管脚电压等于GND电压（将VM与GND短路或连接充电器），就可以进入正常模式。

This function enables the charging of a connected battery whose voltage is 0V by self-discharge. When connects to a charger, the discharging control FET is off and the charging current flows through the internal parasitic diode in the discharging control FET. If the battery voltage becomes equal to or higher than the overdischarge release voltage (VDL), the normal condition returns.

Notes : (1) Some battery providers do not recommend charging of completely discharged batteries. Please refer to battery providers before the selection of 0 V battery charging function.

(2) The 0V battery charging function has higher priority than the abnormal charge current detection function. Consequently, a product with the 0 V battery charging function charges a battery and abnormal charge current cannot be detected during the battery voltage is low.

(3) When a battery is connected to the IC for the first time, the IC may not enter the normal condition in which discharging is possible. In this case, set the VM pin voltage equal to the GND voltage (short the VM and GND pins or connect a charger) to enter the normal condition.

时序图 / Timing Chart
过充和过放电压检测

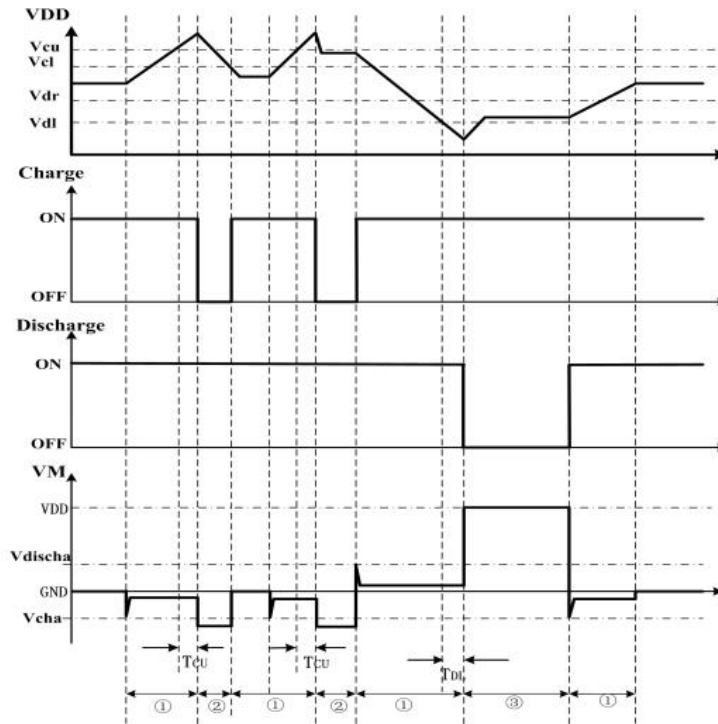

注：(1) 正常情况 (2) 过充电压情况 (3) 过放电电压情况

过充和过放电流检测

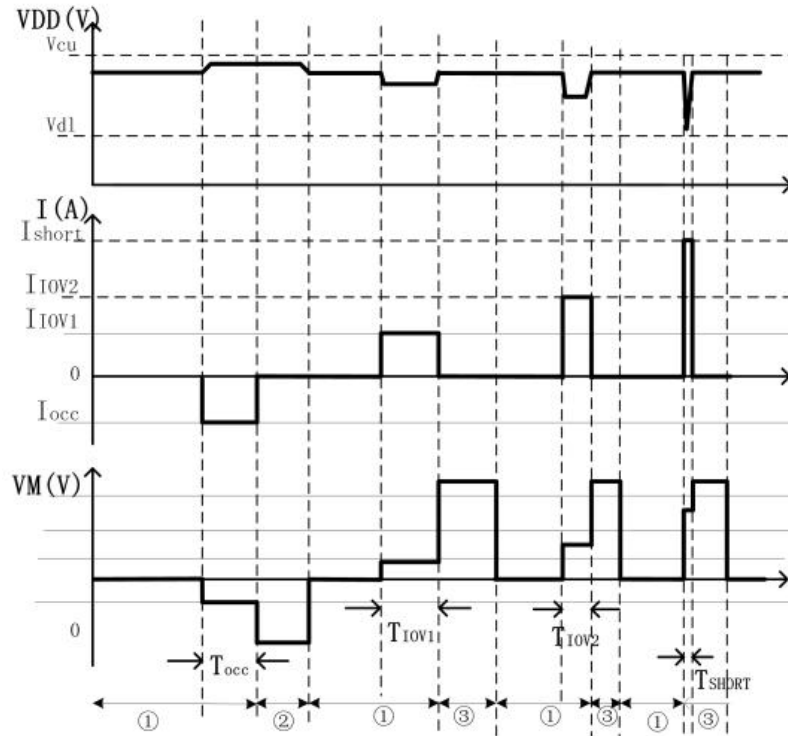

注：(1) 正常情况 (2) 过充电流状态 (3) 过放电流状态

时序图 / Timing Chart

充电器检测

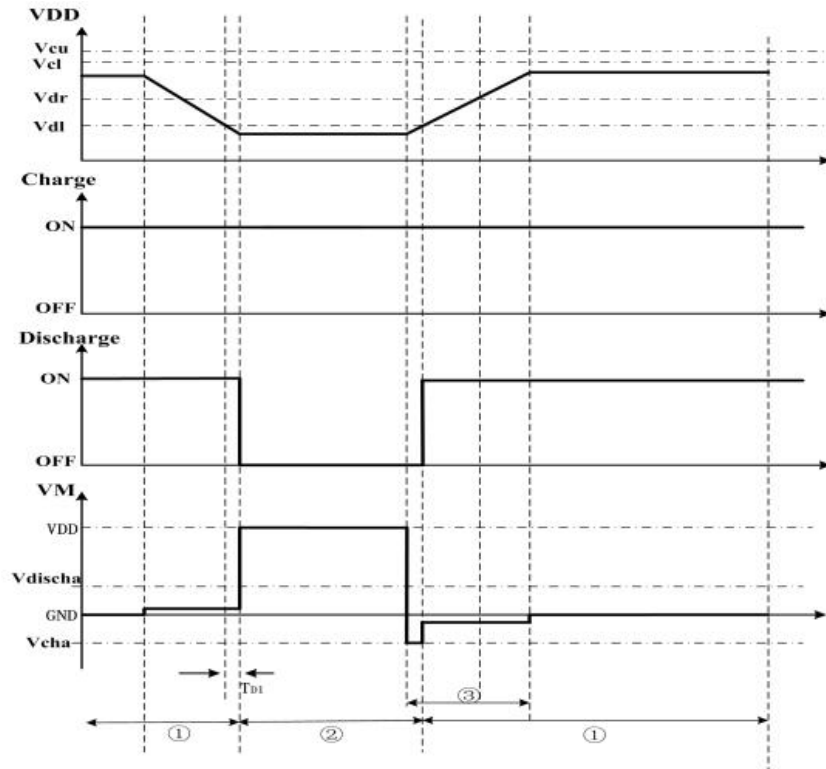

注：(1) 正常情况 (2) 过放电压状态 (3) 充电器接入状态

外形尺寸图 / Package Dimensions

DFN2 ×2-6L-0.5

Unit:mm

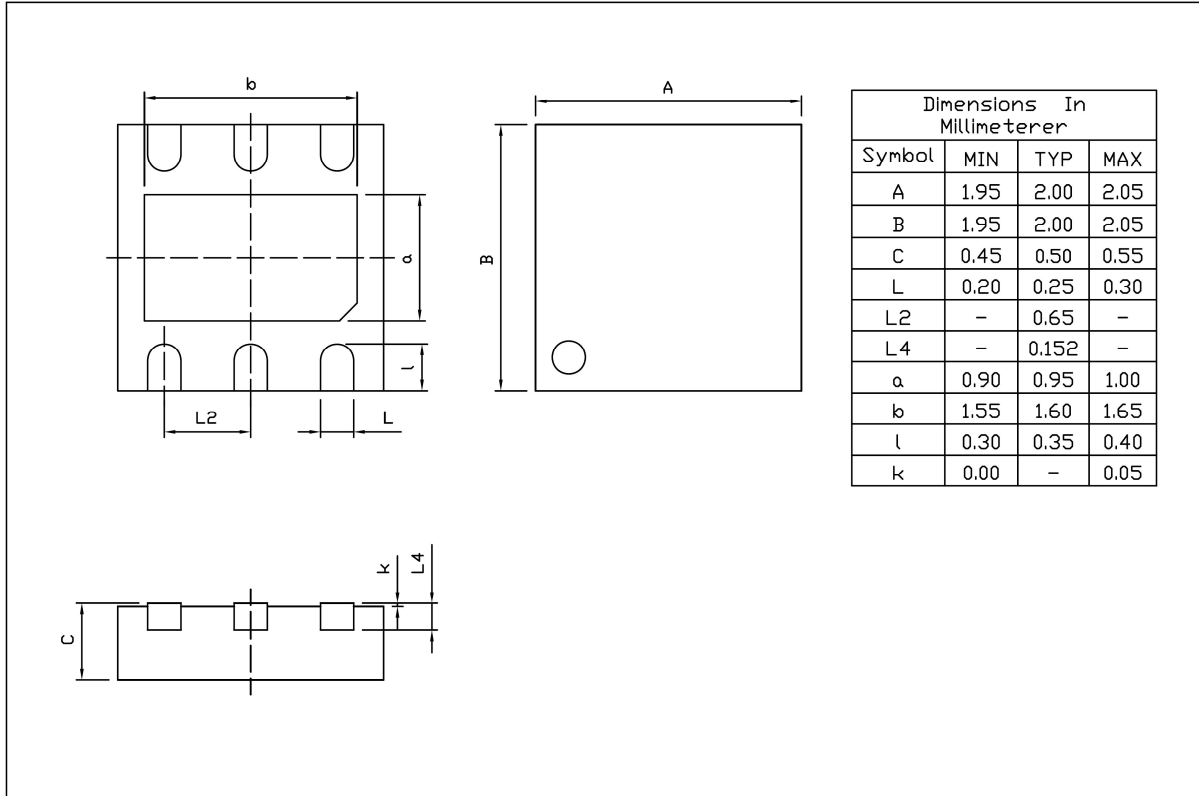

Rev.01 202006

印章说明 / Marking Instructions



正面俯视图

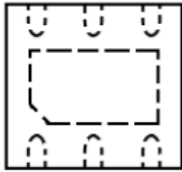

正面透视图

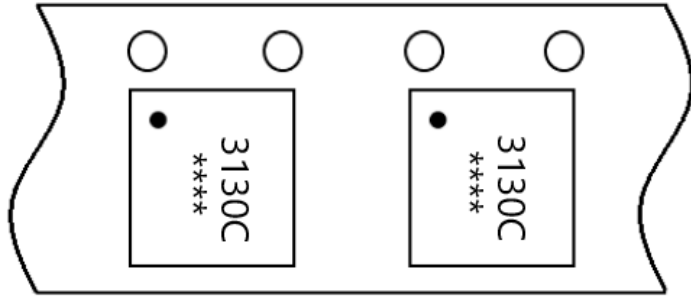

编带示意图

说明：

3130C： 为产品型号

****： 为生产批号代码，随生产批号变化。

Note:

3130C: Product Type.

****: Lot No. Code, code change with Lot No.

回流焊温度曲线图(无铅) / Temperature Profile for IR Reflow Soldering(Pb-Free)

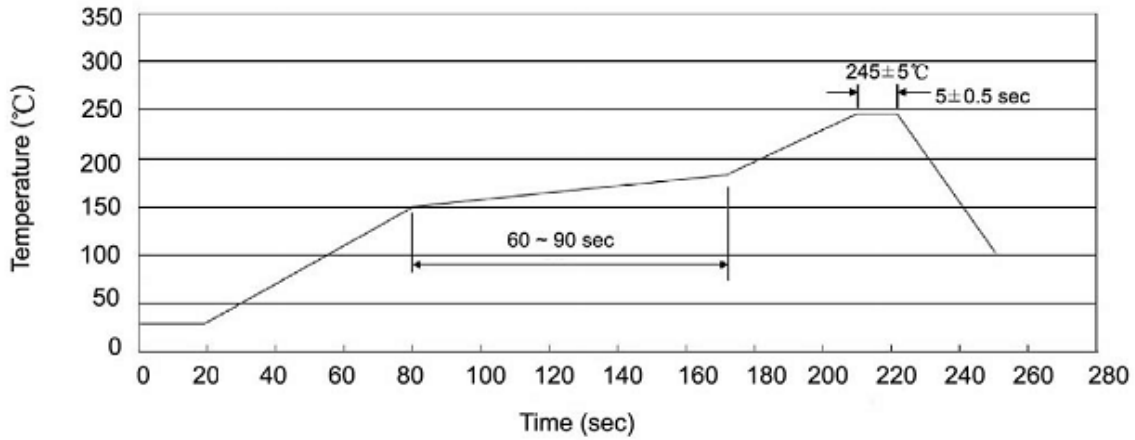

说明：

- 1、预热温度 150~180°C，时间 60~90sec;
- 2、峰值温度 245±5°C，时间持续为 5±0.5sec;
- 3、焊接制程冷却速度为 2~10°C/sec.

Note:

- 1.Preheating:150~180°C, Time:60~90sec.
- 2.Peak Temp.:245±5°C, Duration:5±0.5sec.
3. Cooling Speed: 2~10°C/sec.

耐焊接热试验条件 / Resistance to Soldering Heat Test Conditions

温度：260±5°C

时间：10±1 sec.

Temp.:260±5°C

Time:10±1 sec

包装规格 / Packaging SPEC.

卷盘包装 / REEL

Package Type 封装形式	Units 包装数量					Dimension 包装尺寸 (unit : mm ³)		
	Units/Reel 只/卷盘	Reels/Inner Box 卷盘/盒	Units/Inner Box 只/盒	Inner Boxes/Outer Box 盒/箱	Units/Outer Box 只/箱	Reel	Inner Box 盒	Outer Box 箱
DFN2*2-3L/6L	4,000	10	40,000	4	160,000	7" ×8	210×210×205	445×445×230

使用说明 / Notices