

**描述 / Descriptions**

表面贴装肖特基二极管，反向电压：60V，正向电流：5.0A，薄型 SMBF 封装。  
Surface Mount Schottky Barrier Rectifier, Reverse Voltage:60V,Forward Current:5.0A,SMBF thin package.

**特征 / Features**

低功耗，高效率，浪涌电流大，适用于低压，高频和极性保护，适用于表面贴装。无卤产品。  
Low power loss, high efficiency, High forward surge current capability, For use in low voltage, high frequency inverters, and polarity protection applications,For surface mounted applications.Halogen free product.

**用途 / Applications**

一般用途。  
General purpose.

**内部等效电路 / Equivalent Circuit**



**引脚排列 / Pinning**

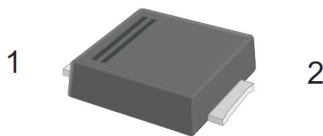

PIN	DESCRIPTION
1	Cathode
2	Anode

The recommended mounting pad size

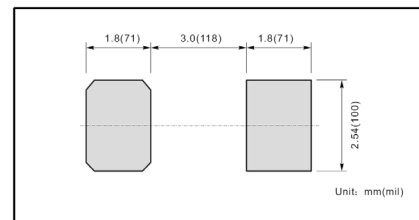

**印章代码 / Marking**

Type number	Marking code
BRLV5T60BF	5T60

**极限参数 / Absolute Maximum Ratings(Ta=25°C)**

参数 Parameter	参数符号 Symbol	数值 Rating	单位 Unit
Maximum Repetitive Peak Reverse Voltage	V <sub>RRM</sub>	60	V
Maximum DC Blocking Voltage	V <sub>R</sub>	60	V
Maximum RMS voltage	V <sub>RMS</sub>	42	V
Maximum Average Forward Rectified Current	I <sub>F(AV)</sub>	5.0	A
Peak Forward Surge Current,8.3ms Single Half Sine-wave Superimposed on Rated Load (JEDEC method)	I <sub>FSM</sub>	120	A
Typical Junction Capacitance <sup>1)</sup>	C <sub>j</sub>	300	pF
Typical Thermal Resistance <sup>2)</sup>	R <sub>θJA</sub>	15	°C/W
Operating Junction Temperature Range	T <sub>j</sub>	-55~+150	°C
Storage Temperature Range	T <sub>stg</sub>	-55~+150	°C

Notes:

- 1 ) Mounted at 1MHz and applied reverse voltage of 4V D.C.
- 2 ) Mounted on a FR4 PCB, single-sided copper, with 100cm<sup>2</sup> copper pad area.

**电性能参数 / Electrical Characteristics(Ta=25°C)**

参数 Parameter	参数符号 Symbol	测试条件 Test condition	数值 Rating			单位 Unit
			MIN.	TYP.	MAX.	
Breakdown Voltage	V <sub>BR</sub>	I <sub>R</sub> =0.5mA Ta=25°C	60			V
Max Instantaneous Forward Voltage	V <sub>F</sub>	I <sub>F</sub> =1.0A Ta=25°C		0.30		V
		I <sub>F</sub> =1.0A Ta=125°C		0.18		
		I <sub>F</sub> =3.0A Ta=25°C		0.35		
		I <sub>F</sub> =3.0A Ta=125°C		0.25		
		I <sub>F</sub> =5.0A Ta=25°C		0.40	0.52	
Maximum DC Reverse Current at Rated DC Reverse Voltage	I <sub>R</sub>	V <sub>R</sub> =42V Ta=25°C		40		μA
		V <sub>R</sub> =60V Ta=25°C			220	μA
		V <sub>R</sub> =60V Ta=125°C		25		mA

电参数曲线图 / Electrical Characteristic Curve

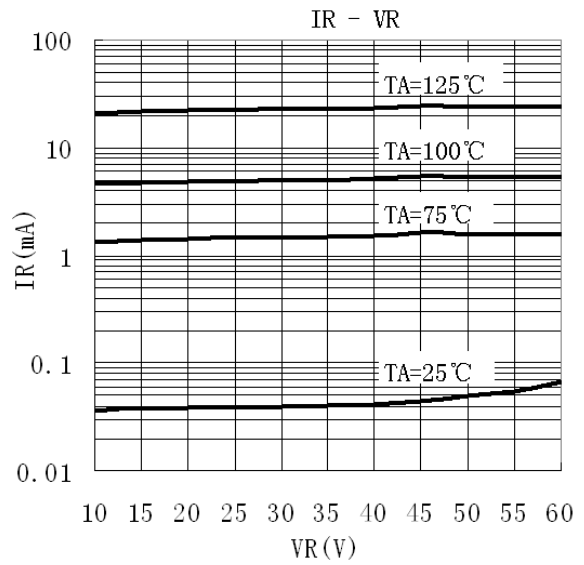
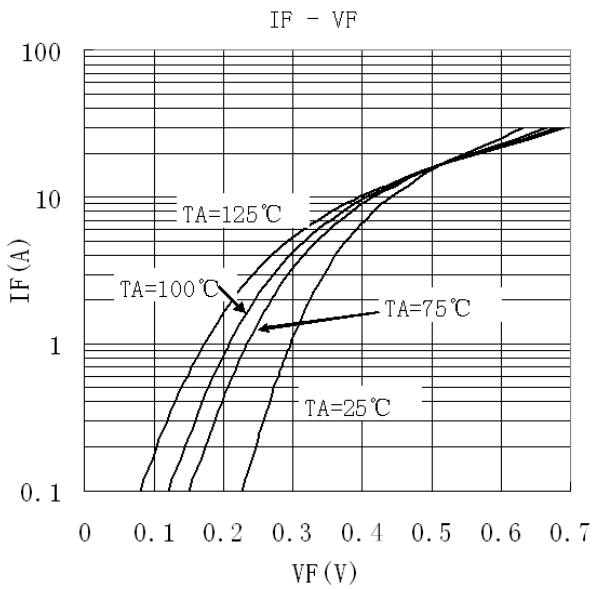
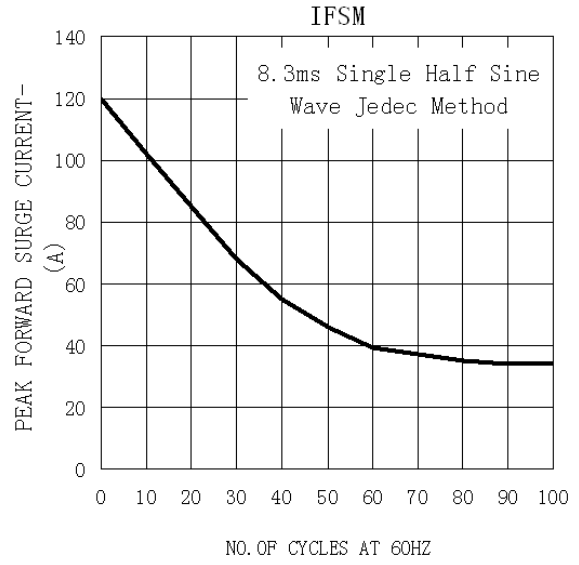
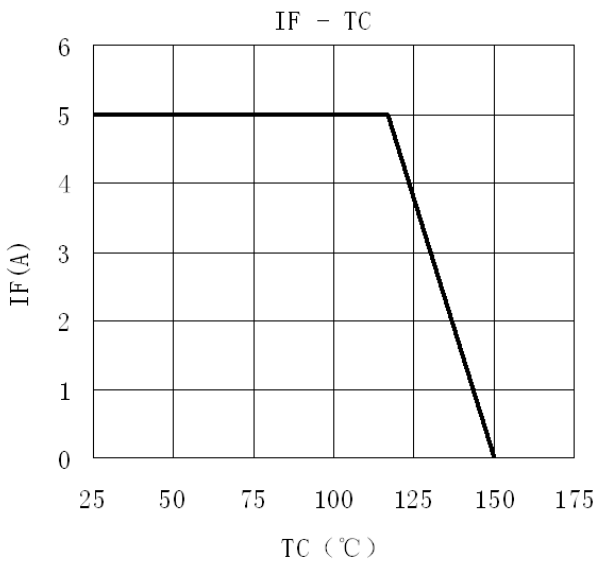

外形尺寸图 / Package Dimensions

SMBF

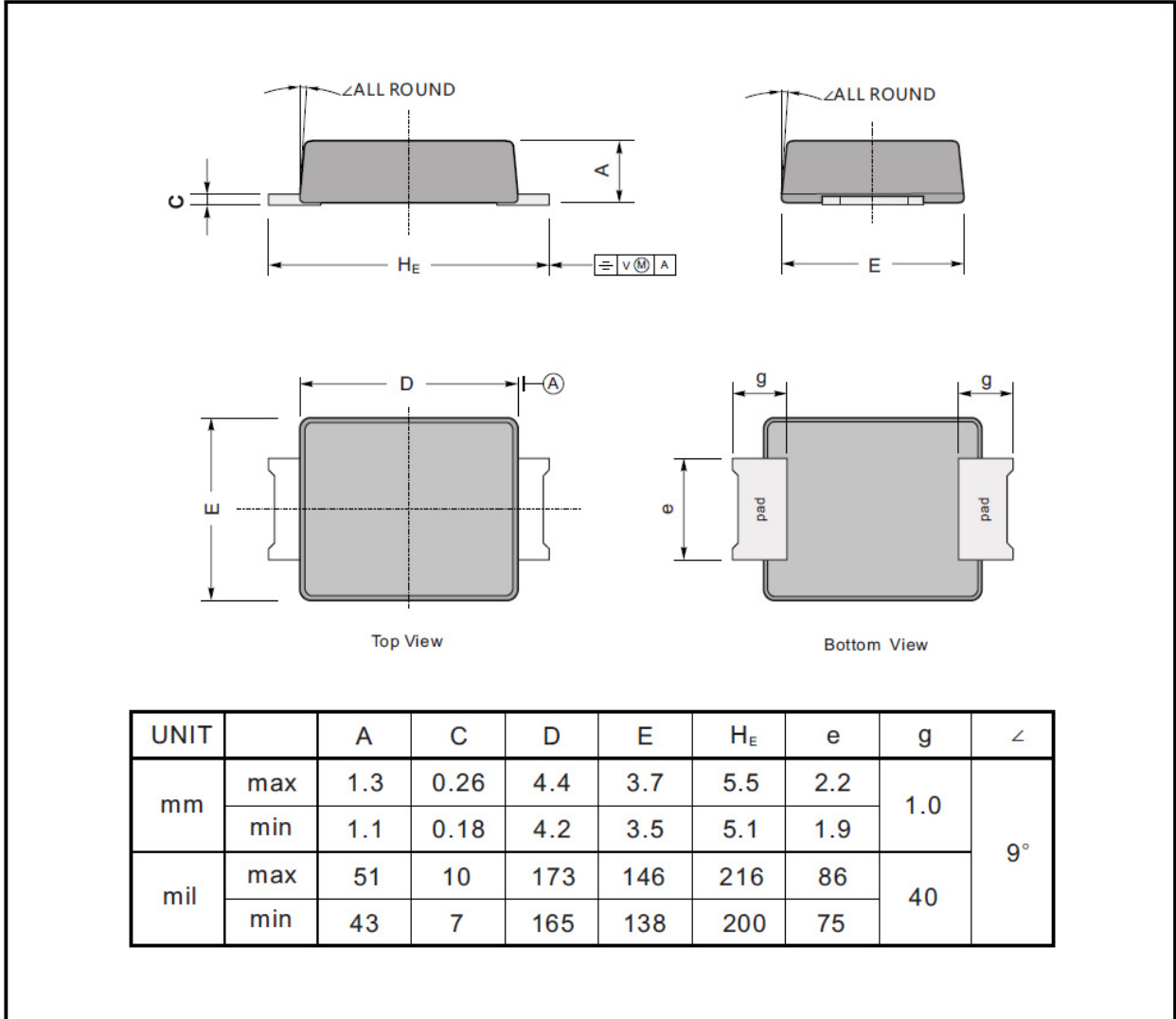

印章说明 / Marking Instructions

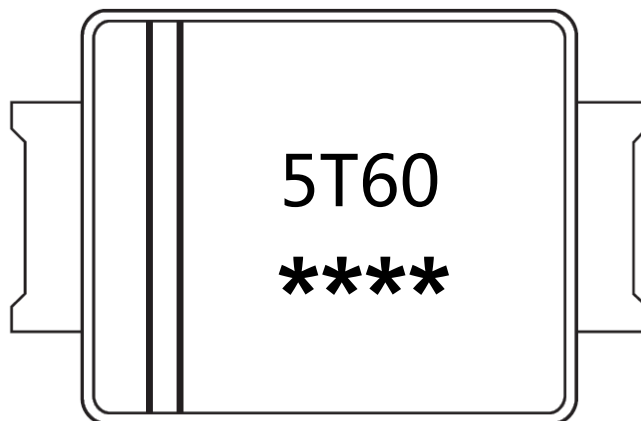

说明：

5T60： 为型号代码

\*\*\*\*： 为生产批号追溯码，第1个\*为年月代码，后面3个\*为当月小批号代码

Note:

5T60： Product Type Code

\*\*\*\*： Lot No. Code , The 1st \* means:YM Code , The last 3 \* means:little Lot No Code

**回流焊温度曲线图(无铅) / Temperature Profile for IR Reflow Soldering(Pb-Free)**

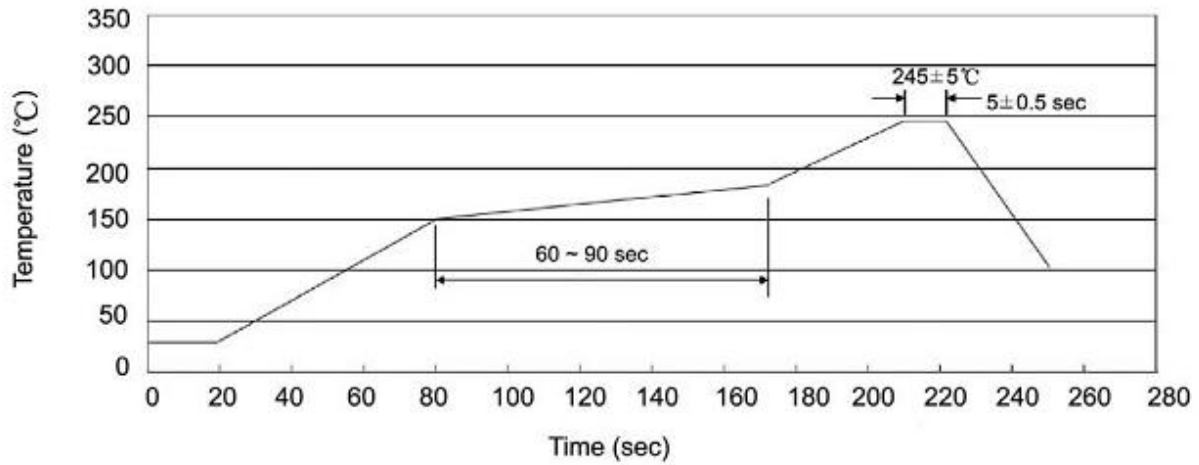

说明：

- 1、预热温度 150~180°C，时间 60~90sec;
- 2、峰值温度 245±5°C，时间持续为 5±0.5sec;
- 3、焊接制程冷却速度为 2~10°C/sec.

Note:

- 1.Preheating:150~180°C, Time:60~90sec.
- 2.Peak Temp.:245±5°C, Duration:5±0.5sec.
3. Cooling Speed: 2~10°C/sec.

**耐焊接热试验条件 / Resistance to Soldering Heat Test Conditions**

温度：260±5°C      时间：10±1 sec.      Temp.:260±5°C      Time:10±1 sec

**包装规格 / Packaging SPEC.**

卷盘包装 / REEL

Package Type 封装形式	Units 包装数量					Dimension 包装尺寸 (unit: mm <sup>3</sup> )		
	Units/Reel 只/卷盘	Reels/Inner Box 卷盘/盒	Units/Inner Box 只/盒	Inner Boxes/Outer Box 盒/箱	Units/Outer Box 只/箱	Reel	Inner Box 盒	Outer Box 箱
SMBF	5000	2	10000	5	50000	13" ×15	336X332X40	380X335X366

**使用说明 / Notices**