

描述 / Descriptions

2A 表面贴装玻璃钝化整流桥，薄型 ABS/LBF 封装。

2A Surface Mount Glass Passivated Bridge Rectifier, ABS/LBF thin package.

特征 / Features

玻璃钝化芯片，反向电压：100V~1000V，正向电流：2.0A，快速反向恢复时间，适用表面贴装。无卤产品。

Glass Passivated Chip Junction, Reverse Voltage :100 to 1000V, Forward Current: 2.0A, Fast reverse recovery time, Designed for Surface Mount Application. Halogen free product.

用途 / Applications

一般用途。

General purpose.

内部等效电路 / Equivalent Circuit

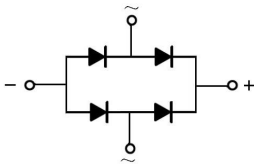

引脚排列 / Pinning

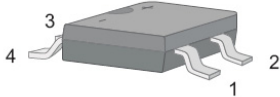

PIN	DESCRIPTION
1	Input Pin (~)
2	Input Pin (~)
3	Output Anode (+)
4	Output Cathode (-)

The recommended mounting pad size

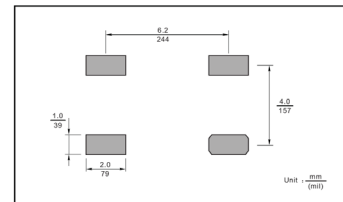

印章代码 / Marking

见印章说明。See Marking Instructions.

极限参数 / Absolute Maximum Ratings(Ta=25°C)

参数 Parameter	符号 Symbol	数值 Rating						单位 Unit
		FTB1S-20	FTB2S-20	FTB4S-20	FTB6S-20	FTB8S-20	FTB10S-20	
Maximum Repetitive Peak Reverse Voltage	V _{RRM}	100	200	400	600	800	1000	V
Maximum RMS voltage	V _{RMS}	70	140	280	420	560	700	V
Maximum DC Blocking Voltage	V _{DC}	100	200	400	600	800	1000	V
Average Rectified Output Current at Tc = 115°C	I _o	2.0						A
Peak Forward Surge Current 8.3 ms Single Half Sine Wave Superimposed on Rated Load (JEDEC Method)	I _{FSM}	50						A
Typical Junction Capacitance ^(Note1)	C _j	30						pF
Typical Thermal Resistance ^(Note2)	R _{θJA}	50						°C/W
Operating and Storage Temperature Range	T _j ,T _{stg}	-55~150						°C

Note:

1. Measured at 1MHz and applied reverse voltage of 4 V D.C.
2. Mounted on glass epoxy PC board with4×1.5"×1.5"(3.81×3.81cm) copper pad.

电性能参数 / Electrical Characteristics(Ta=25°C)

参数 Parameter	符号 Symbol	测试条件 Test Conditions	数值 Rating						单位 Unit
			FTB1S-20	FTB2S-20	FTB4S-20	FTB6S-20	FTB8S-20	FTB10S-20	
Maximum Forward Voltage at 2.0 A	V _F	I _o =2.0A	1.3						V
Maximum DC Reverse Current at Maximum DC Blocking Voltage	I _R	T _a =25°C	5.0						μA
		T _a =125°C	200						μA
Maximum Reverse Recovery Time	t _{rr}	I _F = 0.5 A I _R = 1 A I _{rr} = 0.25 A	350						ns

电参数曲线图 / Electrical Characteristic Curve

Fig.1 Average Rectified Output Current Derating Curve

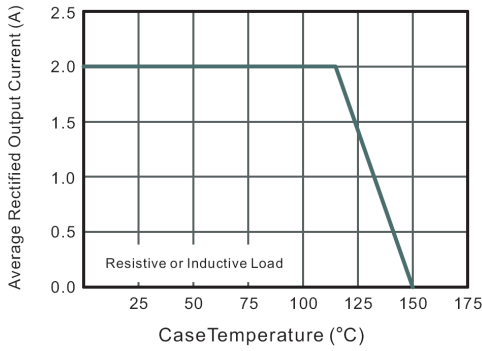

Fig.2 Typical Reverse Characteristics

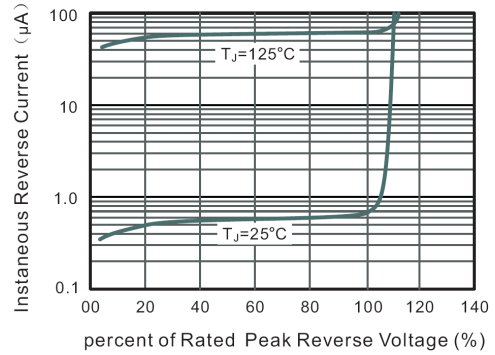

Fig.3 Typical Instantaneous Forward Characteristics

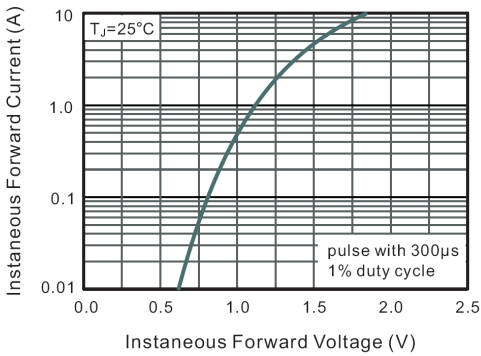

Fig.4 Typical Junction Capacitance

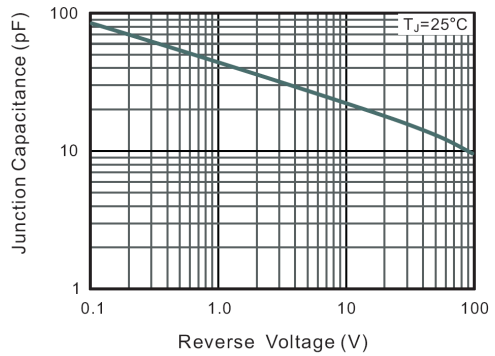
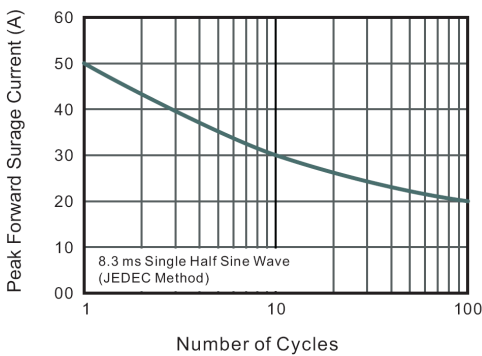
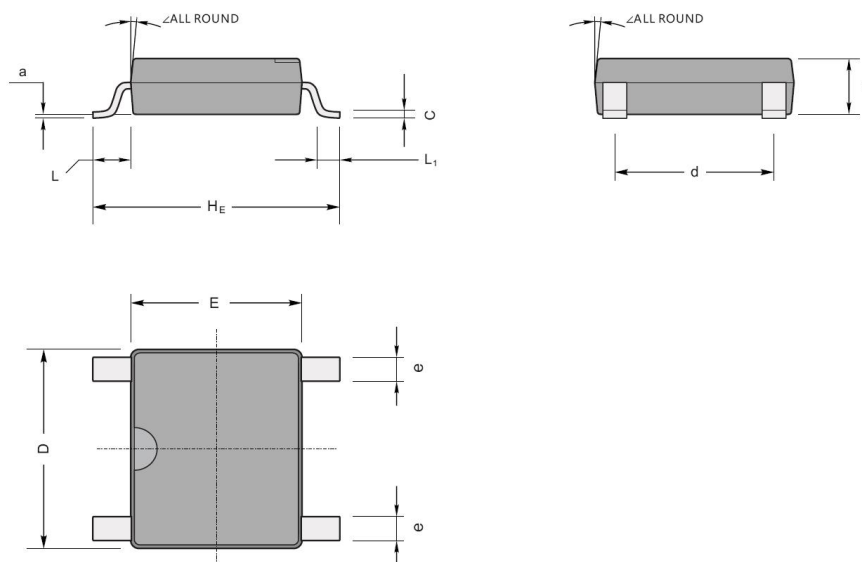

Fig.5 Maximum Non-Repetitive Peak Forward Surge Current



外形尺寸图 / Package Dimensions

ABS/LBF



ABS/LBF mechanical data

UNIT		A	C	D	E	HE	d	e	L	L1	a	∠
mm	max	1.5	0.22	5.2	4.5	6.4	4.2	0.7	0.95	0.6	0.2	7°
	min	1.3	0.15	4.9	4.2	6.0	3.8	0.5				
mil	max	59	8.7	205	177	252	165	28	37	24	4	
	min	51	5.9	193	166	236	150	20				

Marking

Type number	Marking code
FTB1S-20	F20T1
FTB2S-20	F20T2
FTB4S-20	F20T4
FTB6S-20	F20T6
FTB8S-20	F20T8
FTB10S-20	F20T10

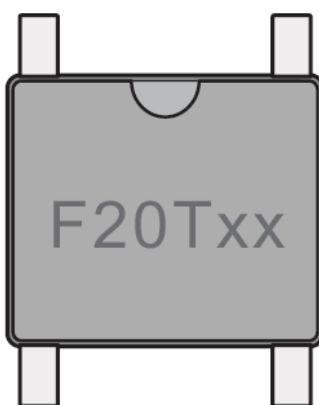

印章说明 / Marking Instructions

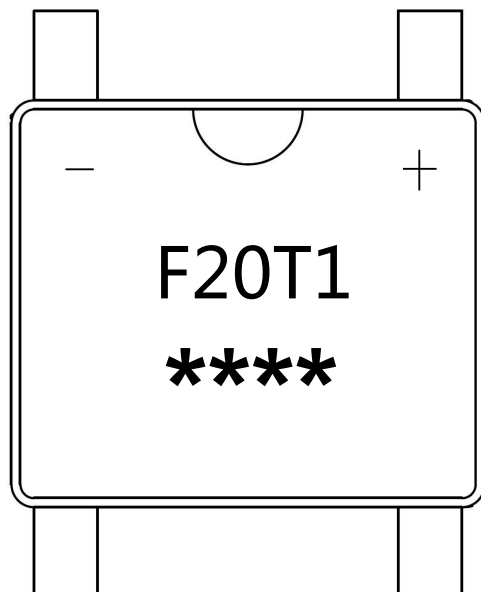

说明：

F20T1： 为型号代码

****： 为生产批号追溯码，第1个*为年月代码，后面3个*为当月小批号代码

Note:

F20T1： Product Type Code

****： Lot No. Code , The 1st * means:YM Code , The last 3 * means:little Lot No Code

回流焊温度曲线图(无铅) / Temperature Profile for IR Reflow Soldering(Pb-Free)

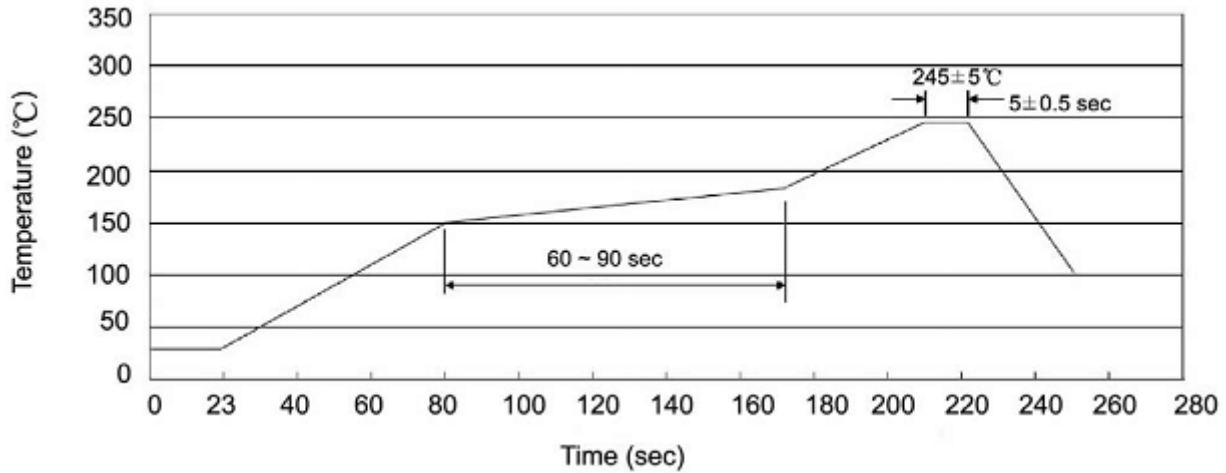

说明：

- 1、预热温度 25 ~ 150°C，时间 60 ~ 90sec;
- 2、峰值温度 245±5°C，时间持续为 5±0.5sec;
- 3、焊接制程冷却速度为 2 ~ 10°C/sec.

Note:

- 1.Preheating:25~150°C, Time:60~90sec.
- 2.Peak Temp.:245±5°C, Duration:5±0.5sec.
3. Cooling Speed: 2~10°C/sec.

耐焊接热试验条件 / Resistance to Soldering Heat Test Conditions

温度：260±5°C

时间：10±1 sec.

Temp.:260±5°C

Time:10±1 sec

包装规格 / Packaging SPEC.

卷盘包装 / REEL

Package Type 封装形式	Units 包装数量					Dimension 包装尺寸 (unit: mm ³)		
	Units/Reel 只/卷盘	Reels/Inner Box 卷盘/盒	Units/Inner Box 只/盒	Inner Boxes/Outer Box 盒/箱	Units/Outer Box 只/箱	Reel	Inner Box 盒	Outer Box 箱
ABS/LBF	5000	2	10000	5	50000	13" ×15	336X336X40	380X335X366

使用说明 / Notices